



# ITT

## ROBOT PUMPS

### Dry Installed Vortex Slurry Pump

### BD4030

The Vortex impeller pumps in wear resistant Nihard 4 are designed to pump a wide variety of highly abrasive solids contaminated liquids in many applications. These pumps are designed for a stationary dry installation of pump and motor.

solids passage : 3" **60 c/s**  
 discharge flange : 4"  
 suction flange : 4"  
 impeller code : 230 / 190  
 recommended minium flow : 95 USGPM

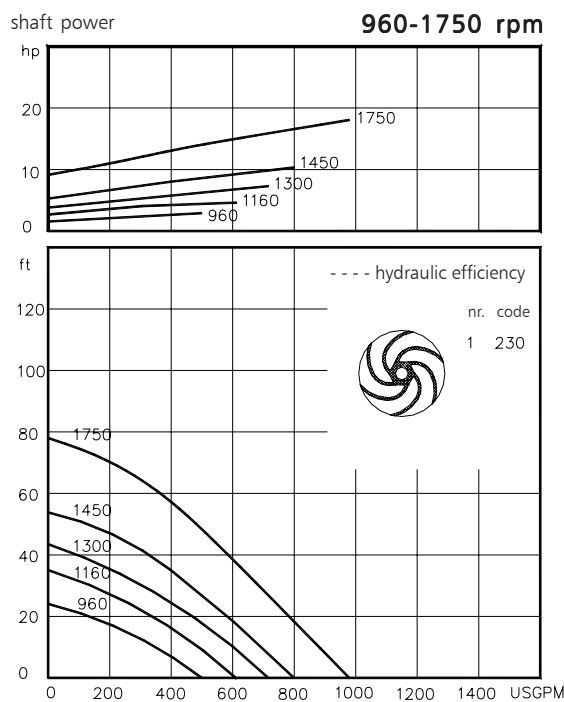
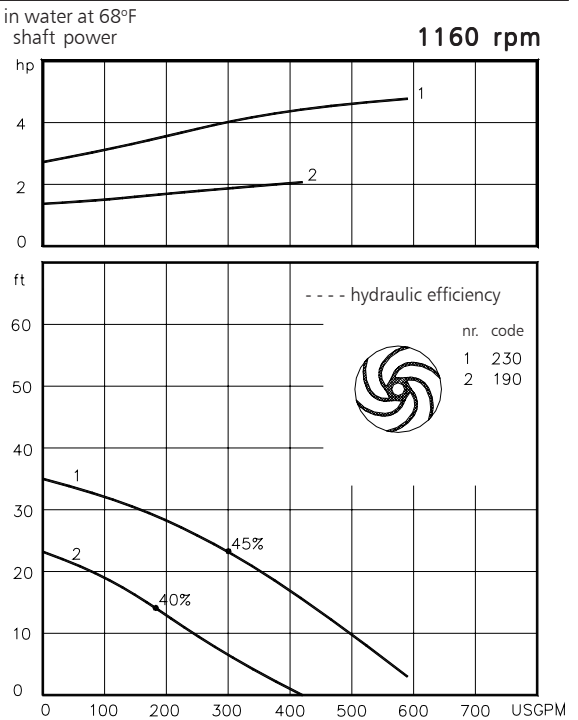
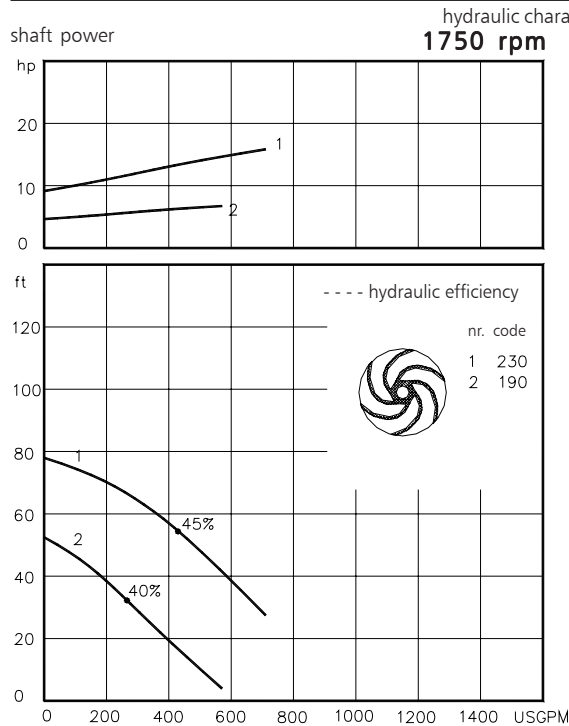

Available electric motors Degree of protection IP55		
NEMA	[hp]	[rpm]
184T	2.0	1160
213T	3.0	1160
215T	5.0	1160
213T	7.5	1750
215T	10	1750
254T	15	1750

[www.ittwwwalphen.com](http://www.ittwwwalphen.com)

*Engineered for life*



# ITT

## ROBOT PUMPS

### Installation options

### BD4030

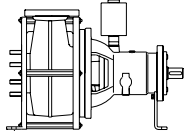

**H**

Horizontal installation:  
Bare shaft

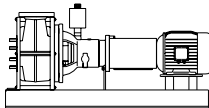

**HM**

Horizontal installation:  
With foundation plate  
and electric motor.

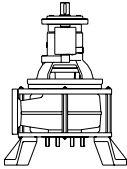

**V**

Vertical installation:  
Bare shaft

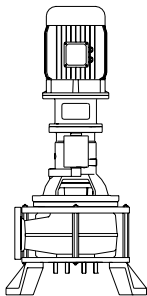

**VM**

Vertical installation:  
With support and electric  
motor.

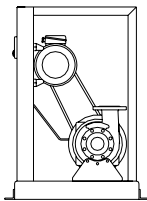

**K**

V-belt driven:  
Frame construction.  
For motors NEMA  
145T - 324T.

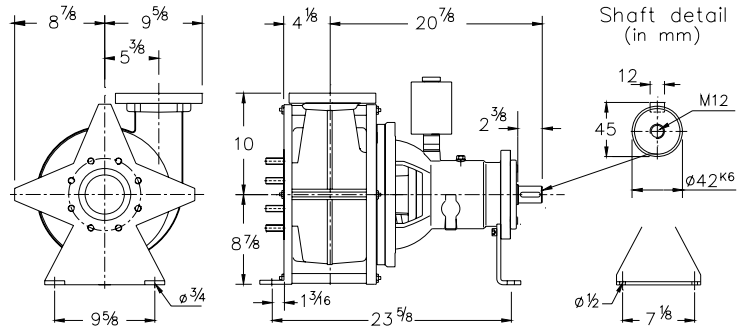

#### Flange connections

		p.c.d.	Standard
Discharge	ND 4	7 1/2	ANSI 150
Suction	ND 4	7 1/2	Number x holes
			8x 3/4
			8x 5/8 UNC

Weight (H version): 244 lbs

#### Optional:

- seal flushing

*Other options and material upon request*

#### Materials

sealhousing	: 1
wear plate	: 6
pump casing	: 6
impeller	: 6
pump shaft	: 3 5
bearing housing	: 1
bolts	: 4 5
elastomer	: 8+9 10
seal lubrication	: oil
pump seal	: silicon carbide-silicon carbide
secondary seal	: carbon - ceramic
primer	: Alkyd primer
top coating	: Two component high-build polyurethane coating

1	cast iron	ASTM A-48 Cl.35
2	sg cast iron	ASTM A445 Gr.60-46-18
3	stainless steel	AISI 431
4	stainless steel	AISI 304
5	stainless steel	AISI 316
6	Nihard 4	(HRC56, HB555)
7	wear resistant sg iron	HB500
8	nitrile	(NBR)
9	neoprene	(CR)
10	viton	(FPM)

We reserve the right to alter specifications without prior notice.