



ITT

ROBOT PUMPS

Turbotex Pump

RT4040DU

60 c/s

Turbotex pumps are auto cleaning solids handling pumps. The impeller leading edge is almost parallel with the direction of the flow and leads into the impeller passage. Turbotex pumps are first choice for raw unscreened sewage as well as for lightly contaminated liquids.

Pump

solids passage : 4"
 suction diameter : 4 3/4"
 discharge diameter : 4"
 impeller diameter : 215 - 185
 recommended minimum flow : 95 USGPM

Motor

rated horse power : 16.5 hp
 rated electrical power : 14.0 kW
 rated kVA : 15.9 kVA
 mains : 60 c/s - 3 phase
 speed : 1750 rpm
 rated efficiency : 88 %
 rated power factor (cos phi) : 0.88
 degree of protection : IP 68
 isolation class : F (311 °F)
 max. water temperature : 104 °F
 (higher temperatures on request)
 standard cable length : 33 ft
 max. submersion depth : 66 ft

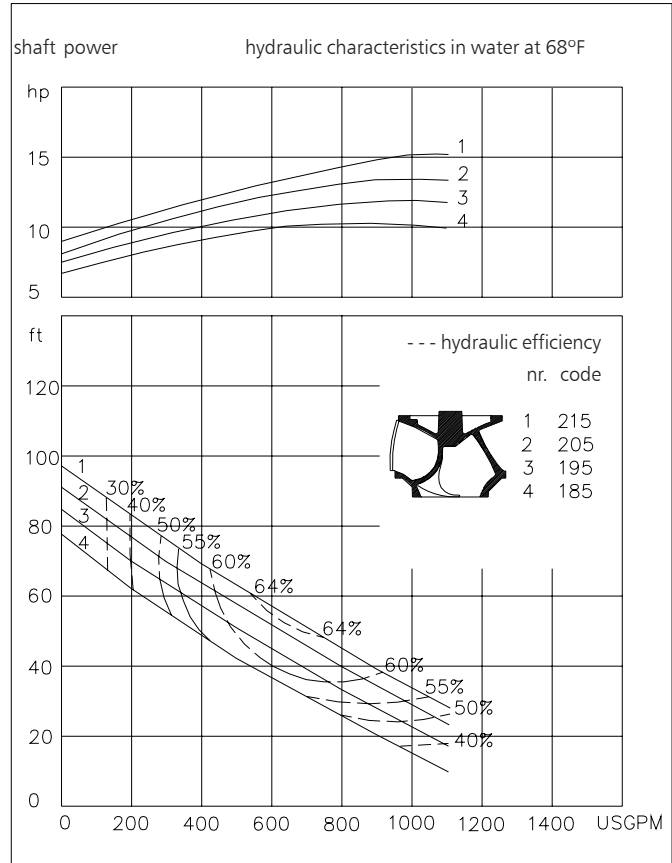

15.9 USGPM = 1 l/s 1 hp = 0.736 kW 1 ft = 0.3 m 1 lb = 0.45 kg

Materials

motor housing : 1
 seal housing : 1
 volute : 1
 impeller : 2 7
 shaft : 3 5
 bolts : 4 5
 cooling jacket : 5
 elastomers : 8+9 10
 electrical cable : 9
 seal lubrication : oil
 pump seal : silicon carbide-silicon carbide
 motor seal : carbon - ceramic
 primer : Alkyd primer
 top coating : Two component high-build polyurethane coating

1	cast iron	ASTM A-48 Cl.35
2	sg cast iron	ASTM A445 Gr.60-46-18
3	stainless steel	AISI 431
4	stainless steel	AISI 304
5	stainless steel	AISI 316
6	bronze	ASTM B 145 Gr. 4a
7	wear resistant sg iron	HB500
8	nitrile	(NBR)
9	neoprene	(CR)
10	viton	(FPM)

www.ittwwwalphen.com

Engineered for life



ITT

ROBOT PUMPS

Installation options

RT4040DU

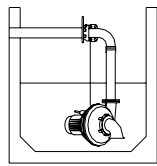

H
Header coupling:
Type HK100

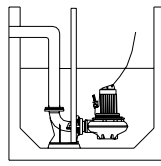

V
Guide bar coupling:
Type V100

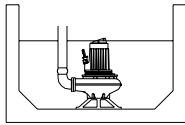

F
Freestanding:
With support and
4" hose adapter

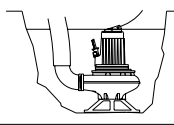

T
Transportable:
With support and
4" hose adapter

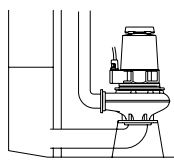

A
Immersible:
vertical or horizontal
with cooling system and
support.
Discharge: 4"
Suction: 5"

The motor is cooled by the surrounding water.
With cooling version the motor can run continuously above the waterlevel

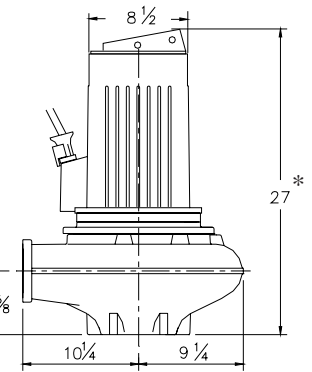
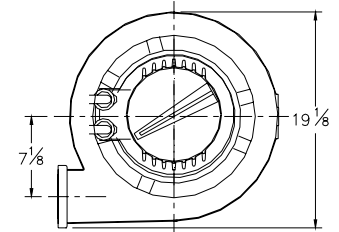
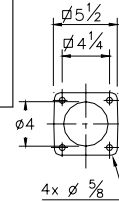

* Version P: 29

Versions

B Basic version

Weight

288 lbs

P FM approved version

317 lbs

Certified according to:
Class I, Division I, Groups C&D T4
Standard with thermostats and
waterdetector in motorhousing.

C Version with cooling system

317 lbs

Internal or external circulation
(ext. coolingwater min. flow 2.4 USGPM)

Optional:

Thermostiches in motorwindings
Standard for FM approved version

Flexible protective sheathing for cable
(AISI 316)

Water detector in motor and oil housing (for flame proof version only in oil housing with external cable)

Motor connection details

voltage [V]*	rated curr.[A]	electrical cable size					
				with waterdetector and/or thermostiches		FM approved version	
		DOL-start	YD-start	DOL- start	YD-start	DOL start	YD start
220	41.9	2xAWG 10/4	2xAWG 10/4	-	-	-	-
380	24.3	1xAWG 10/4	1xAWG 14/7	1xAWG 10/4+1xAWG 14/4	1xAWG 14/7+1xAWG 14/4	1xAWG 10/4+1xAWG 14/7	2xAWG 14/7
440	20.9	1xAWG 12/4	1xAWG 14/7	1xAWG 12/4+1xAWG 14/4	1xAWG 14/7+1xAWG 14/4	1xAWG 12/4+1xAWG 14/7	2xAWG 14/7
460	20.0	1xAWG 12/4	1xAWG 14/7	1xAWG 12/4+1xAWG 14/4	1xAWG 14/7+1xAWG 14/4	1xAWG 12/4+1xAWG 14/7	2xAWG 14/7
575	16.0	1xAWG 12/4	1xAWG 14/7	1xAWG 12/4+1xAWG 14/4	1xAWG 14/7+1xAWG 14/4	1xAWG 12/4+1xAWG 14/7	2xAWG 14/7

starting current DOL start : 5.0 x rated current

*other voltages on request

starting current YD-start : 1.7 x rated current

We reserve the right to alter specifications without prior notice.