

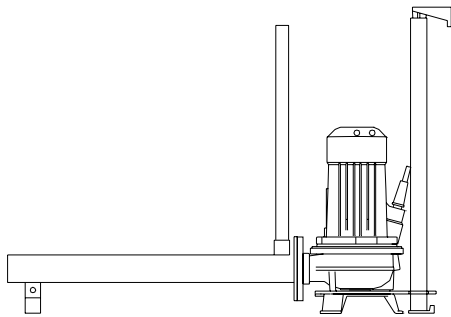

Technical Information

RSB 70 with RW pump

- Pump type:
 1 RW2110BD ø125
 2 RW2110BE ø138
 3 RW2110BH ø150



- solids passage ø35 mm

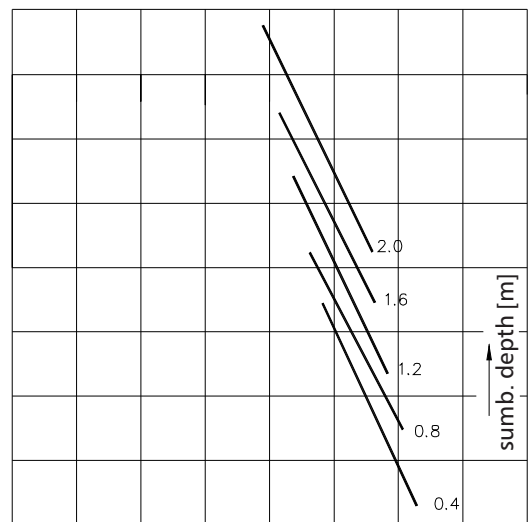
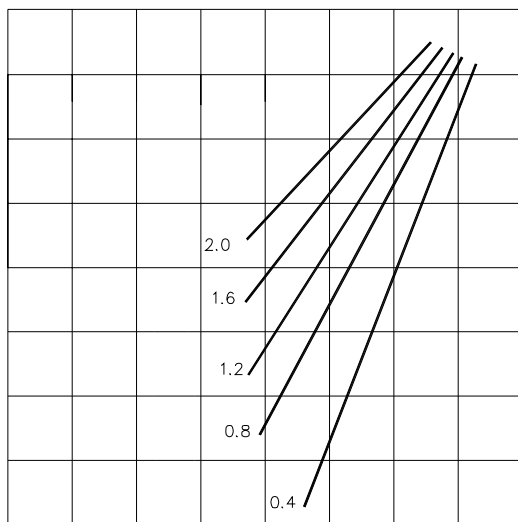
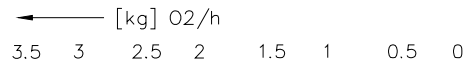
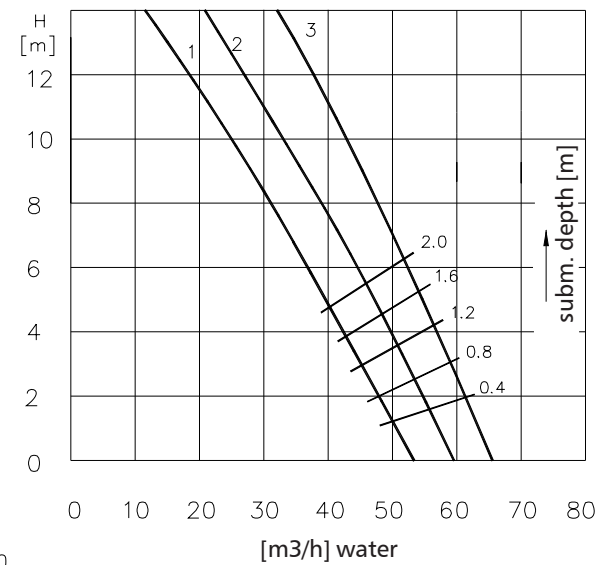
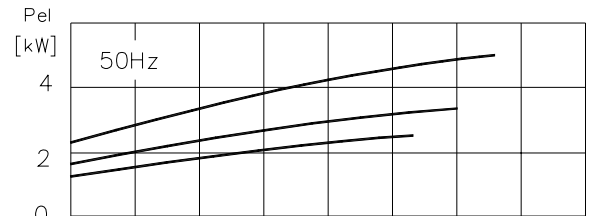



ITT

ROBOT PUMPS

Technical Information

RSB 100 with RT pump

- Pumptype:
 1 RT2030DG ø1190
 2 RT4040DJ ø1195
 3 RT4040DL ø207
 4 RT4040DO ø226

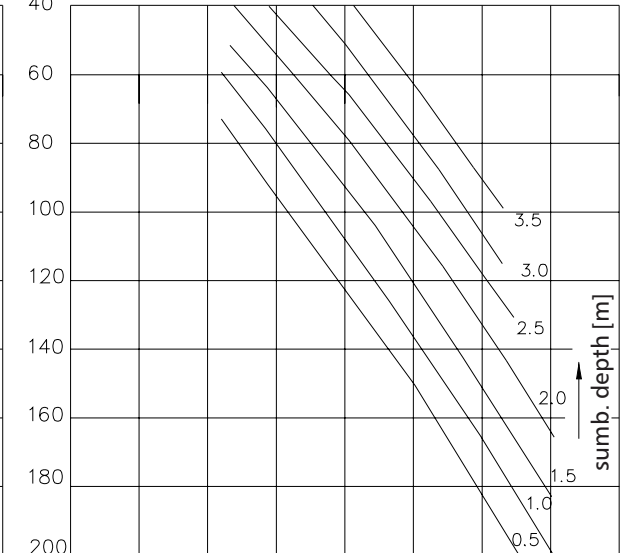
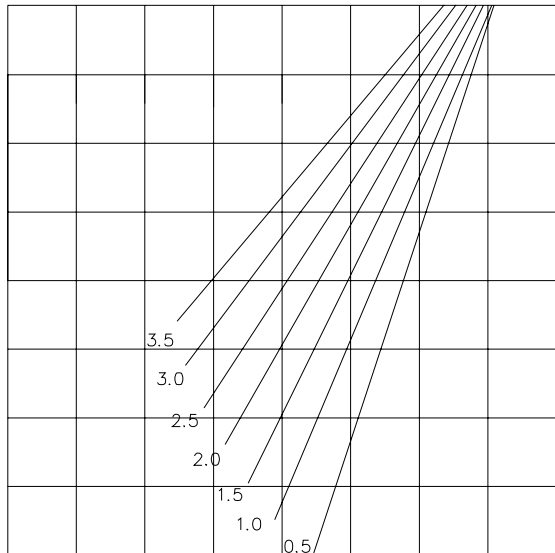
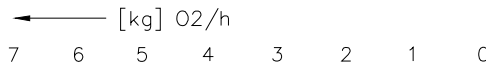
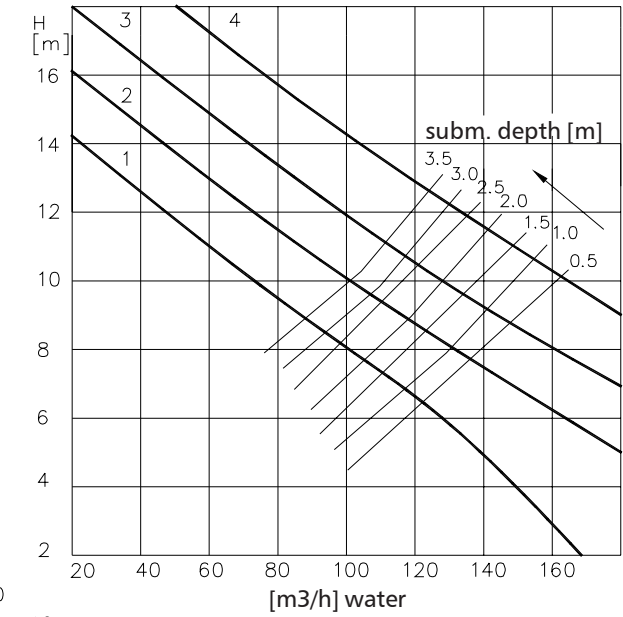
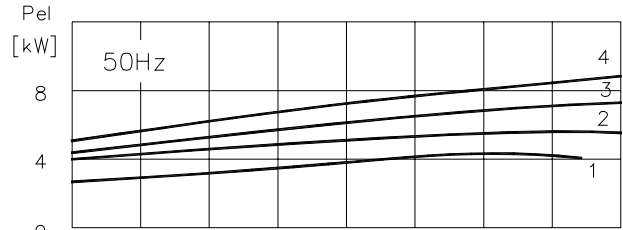
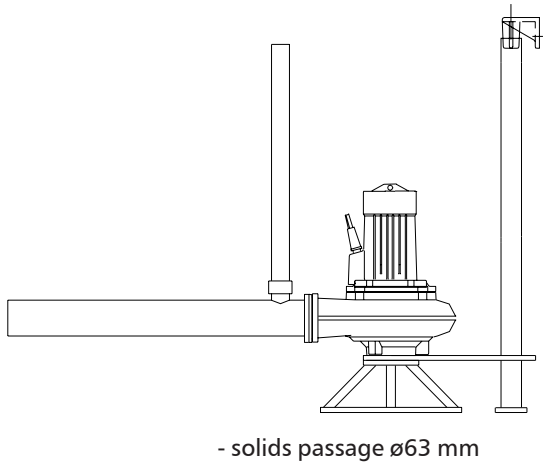



ITT

ROBOT PUMPS

Technical Information

RSB 100 with RW pump

Pump type:

- 1 RW4030DJ ø215
- 2 RW4030DL ø230
- 3 RW4030DO ø245
- 4 RW4041DU ø245

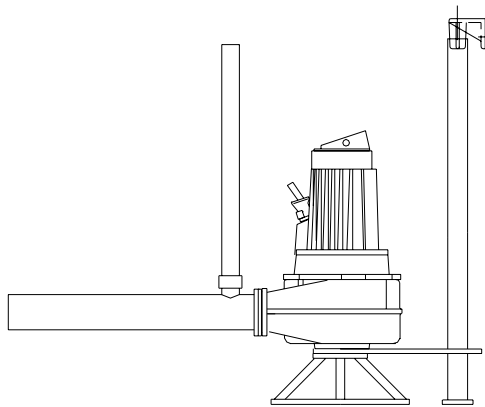

- solids passage ø63 mm

← [kg] O₂/h
7 6 5 4 3 2 1 0

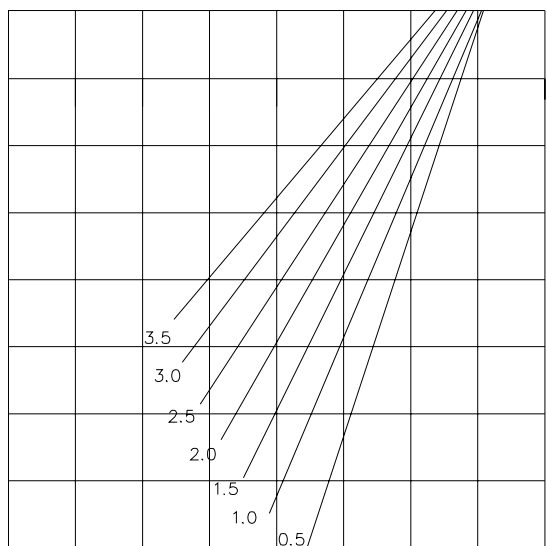
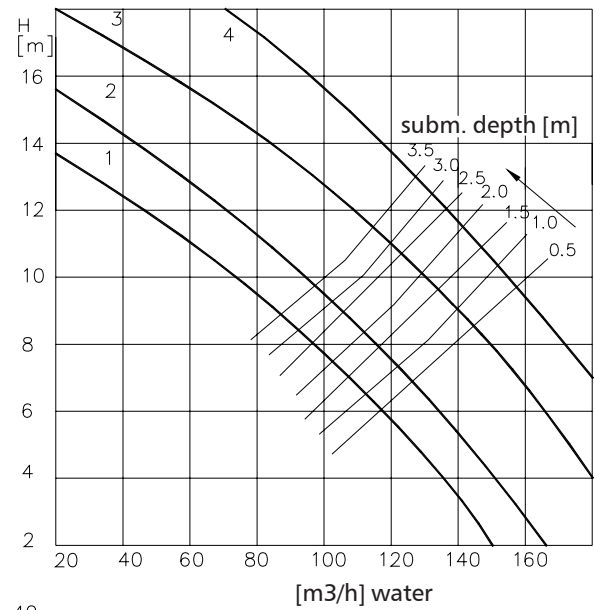
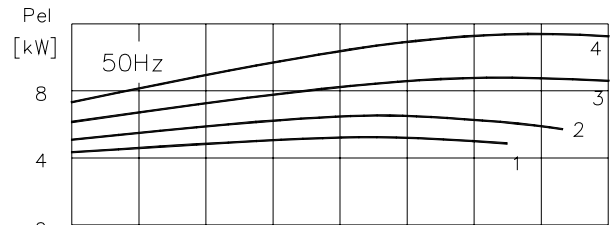

← subm. depth [m] [m³/h] air

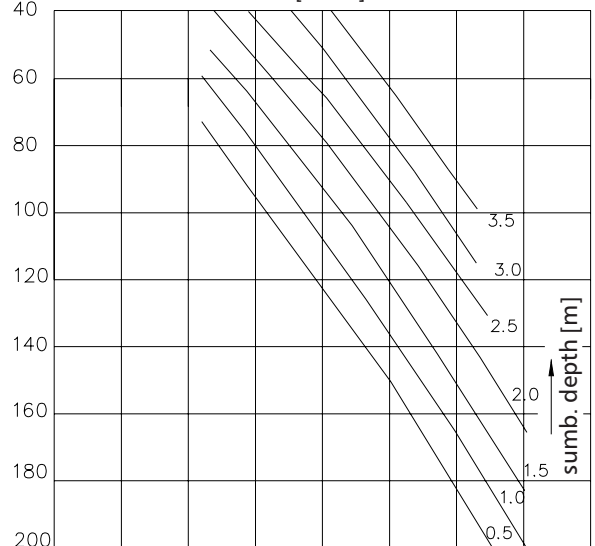



ITT

ROBOT PUMPS

Technical Information

RSB 150 with RT pump

Pump type:
 1 RT4042DU \varnothing 235
 2 RT4042DZ \varnothing 245

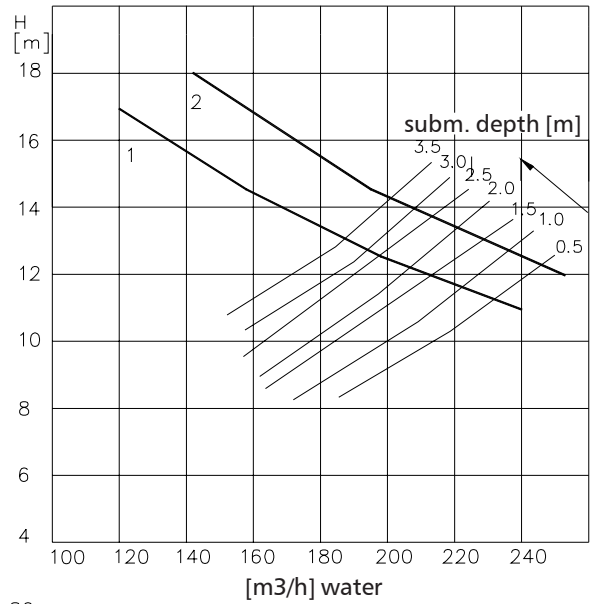
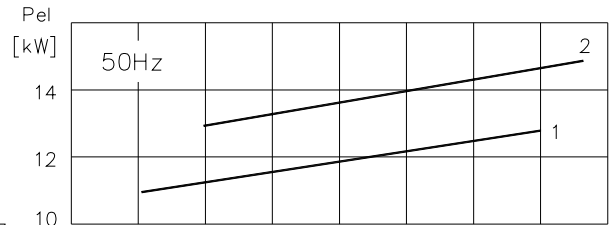
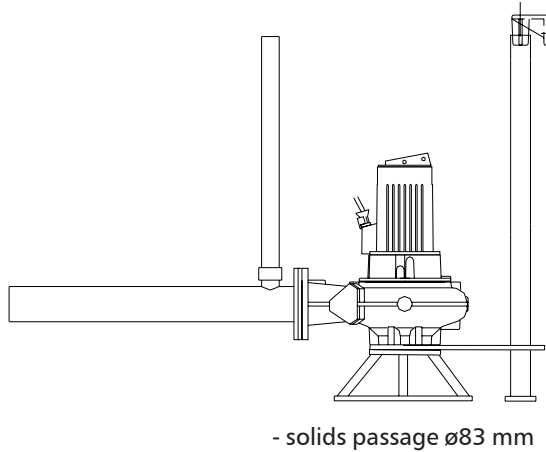

← [kg] O₂/h
 9 8 7 6 5 4 3 2

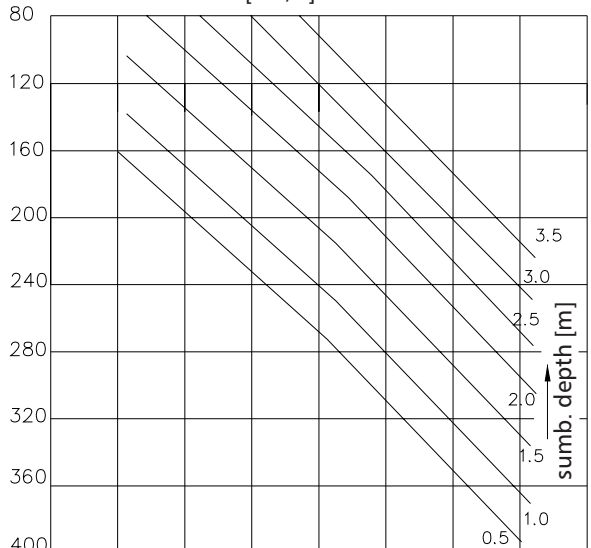
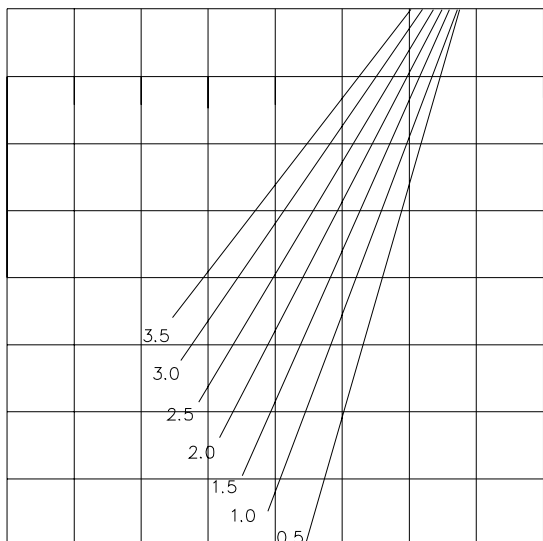



Technical Information

RSB 150 with RW pump

Pump type:
1 RW6141LD ø215
2 RW6141LF ø225
3 RW6141LF ø235

