



ITT

ROBOT PUMPS

Channel pump

RC2215BE

50 Hz

The channel impeller pumps are designed to pump lightly contaminated waste water at high efficiencies. RC pumps are equipped with an open channel impeller running against an adjustable suction cover.
Excellent for drainage or leakage water.

Pump	3 channels
solids passage	: 30 mm
suction diameter	: 80 mm
discharge diameter	: 65 mm
impeller diameter	: 93 mm
recommended minimum flow	: 2 l/s (8 m ³ /h)

Motor	
rated shaft power	: 2.6 kW
rated electrical power	: 3.5 kW
mains	: 50 Hz - 3 phase
speed	: 2900 rpm
motor efficiency	: 74 %
rated power factor (cos phi)	: 0.90
degree of protection	: IP 68
isolation class	: F (155 °C)
max. water temperature (higher temp. on request)	: 40 °C
standard cable length	: 10 m

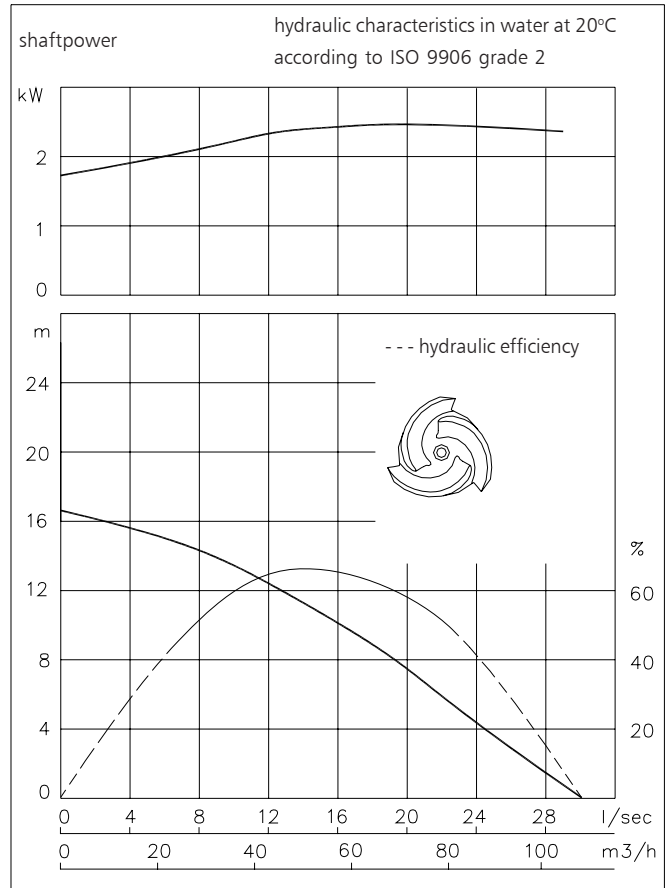

Pump curves are for cast iron only.

Materials

motor housing	: 1
seal housing	: 1
volute	: 1
impeller	: 1
suction cover	: 1
shaft	: 3 5
bolts	: 4 5
elastomers	: 8+9 10
electrical cable	: 9
mechanical seals	: oil lubricated
pump seal	: silicon carbide-silicon carbide
motor seal	: carbon-ceramic
primer	: Alkyd primer
top coating	: Two component high-build polyurethane coating

1	cast iron	EN-GJL-250
2	sg cast iron	EN-GJS-400-15
3	stainless steel 431	X20 CrNi 17 2
4	stainless steel 304	X5 CrNi 18 10
5	stainless steel 316	X5 CrNiMo 17 12 2
6	stainless steel 329	X4 CrNiMoN 27 5 2
7	wear resistant sg iron	HB 500
8	nitrile	(NBR)
9	neoprene	(CR)
10	viton	(FPM)

www.ittwalphen.com

Engineered for life



ITT

ROBOT PUMPS

Installation options

RC2215BE

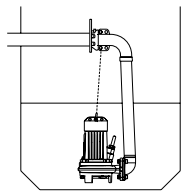

H
Header coupling:
Type HK65 or HK80

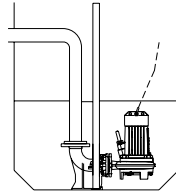

V
Guide bar coupling:
Type V65-N

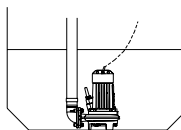
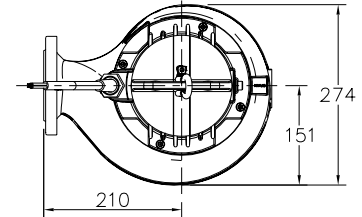

F
Freestanding:
With 75mm hose adapter
or R2.5" or R3" threaded
connection

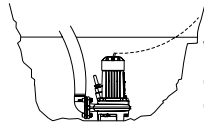

T
With 75mm hose adapter
or R2.5" or R3" threaded
connection

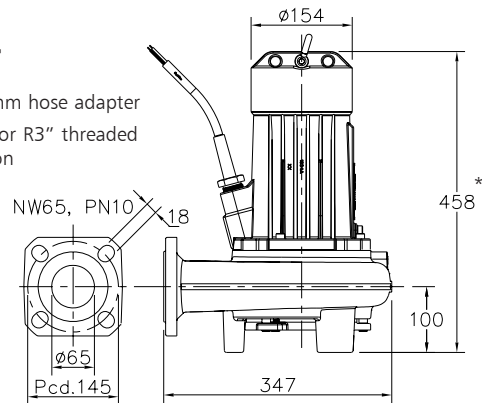

* version E: 558

The motor is cooled by the surrounding water.

Version

B Basic

Weight

51 kg

E Explosion proof version

Certified according to: II 2 G Ex de IIB c T4

58 kg

Optional:

Thermoswitches in motorwindings
Standard for explosion proof version (2 sets)

Flexible protective sheathing for cable
(AISI 316)

Water detector in motor and oil housing
(for explosion proof version only in oil housing with
external cable)

Motor connection details

voltage [V]*	rated current[A]	number of cables x number of cores x cross section [mm ²]					
		DOL-start		YD-start		explosion proof version	
220	10.2	1x4x1.5	1x7x1.5	1x7x1.5	1x10x1.5	1x7x2.5	
380	5.9	1x4x1.5	1x7x1.5	1x7x1.5	1x10x1.5	1x7x2.5	
400	5.6	1x4x1.5	1x7x1.5	1x7x1.5	1x10x1.5	1x7x2.5	
415	5.4	1x4x1.5	1x7x1.5	1x7x1.5	1x10x1.5	1x7x2.5	
500	4.5	1x4x1.5	1x7x1.5	1x7x1.5	1x10x1.5	1x7x2.5	

starting current DOL-start : 4.6 x rated current

* other voltages on request

starting current YD-start : 1.5 x rated current

We reserve the right to alter specifications without prior notice.