



ITT

ROBOT PUMPS

Slurry Pump

RD4021BJ

60 c/s

Vortex impeller pump in wear resistant Nihard 4 for reliable transport of highly abrasive solids in high concentrations.

Pump

solids passage : 2 1/2"

suction diameter : 2 7/8"

discharge diameter : 2 1/2"

impeller diameter : 135

recommended minimum flow : 32 USGPM

Motor

rated horse power : 7.8 hp

rated electrical power : 7.1 kW

rated kVA : 7.9 kVA

mains : 60 c/s - 3 phase

speed : 3500 rpm

rated efficiency : 82 %

rated power factor (cos phi) : 0.90

degree of protection : IP 68

isolation class : F (311 °F)

max. water temperature : 104 °F
(higher temperatures on request)

standard cable length : 33 ft

max. submersion depth : 66 ft

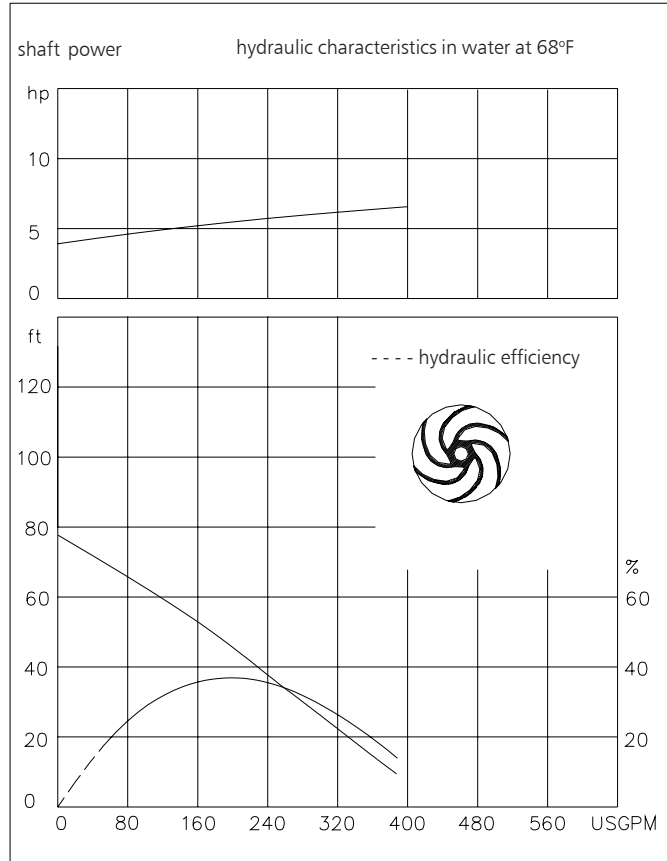

Materials

motor housing : 1

seal housing : 7

volute : 7

hose adapter : 7

impeller : 7

shaft : 3 5

bolts : 4 5

elastomers : 7+8 10

electrical cable : 8

seal lubrication : oil

pump seal : silicon carbide-silicon carbide

motor seal : carbon-ceramic

primer : Alkyd primer

top coating : Two component high-build polyurethane coating

1	cast iron	ASTM A-48 Class 35
2	sg cast iron	ASTM A445 Gr.60-46-18
3	stainless steel	AISI 431
4	stainless steel	AISI 304
5	stainless steel	AISI 316
6	bronze	ASTM B145 Gr. 4a
7	Nihard 4	ASTM A532, class I, type D
8	nitrile	(NBR)
9	neoprene	(CR)
10	viton	(FPM)

www.ittwalphen.com

Engineered for life



ITT

ROBOT PUMPS

Installation options

RD4021BJ

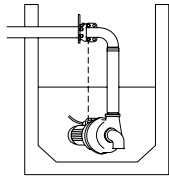

H

Header coupling:
Type HK65 or HK80

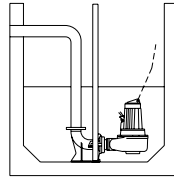

V

Guide bar coupling:
Type V65 or V80

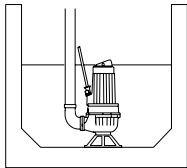
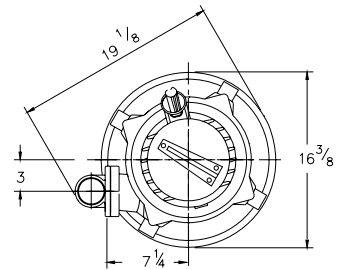

F

Freestanding:
With support and
3" hose adapter
or NPT threaded
connection

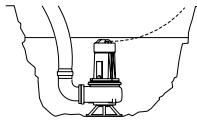

T

Transportable:
With support and
3" hose adapter
or NPT threaded
connection

Without cooling system the motor is cooled by the surrounding water.

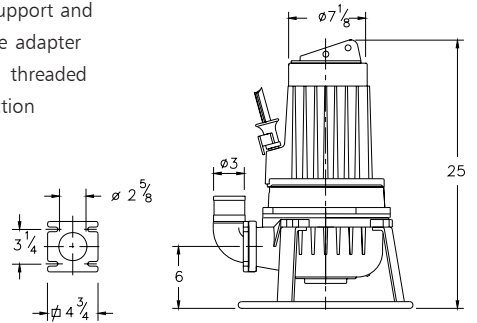

Versions

B Basic version

Weight

196 lbs

Optional:

Thermoswitches in motor windings

Flexible protective sheathing for cable
(AISI 316)

Water detector in motor and oil housing

Motor connection details

voltage [V]*	rated current [A]	electrical cable size			
		without waterdetector and/or thermoswitches		with waterdetector and/or thermoswitches	
		DOL-start	YD-start	DOL-start	YD-start
220	20.6	1xAWG 10/4	1xAWG 14/7	-	-
380	11.9	1xAWG 14/4	1xAWG 16/7	1xAWG 14/7	1xAWG 16/10
440	10.4	1xAWG 14/4	1xAWG 16/7	1xAWG 14/7	1xAWG 16/10
460	9.9	1xAWG 14/4	1xAWG 16/7	1xAWG 14/7	1xAWG 16/10
575	7.9	1xAWG 14/4	1xAWG 16/7	1xAWG 14/7	1xAWG 16/10

starting current DOL-start : 6.2 x rated current

starting current YD-start : 2.1 x rated current

* other voltages on request

We reserve the right to alter specifications without prior notice.