



# ITT

## ROBOT PUMPS

### Dry Installed Vortex Pump

### BW4041

The dry installed vortex pumps are designed to pump a wide variety of solids contaminated liquids. They are used for sewage and other waste water applications. These pumps are designed for a stationary dry installation of pump and motor.

solids passage : 4" **60 c/s**  
 discharge flange : 4"  
 suction flange : 5"  
 impeller code : 252-210  
 recommended minium flow : 95 USGPM

hydraulic characteristics in water at 68°F

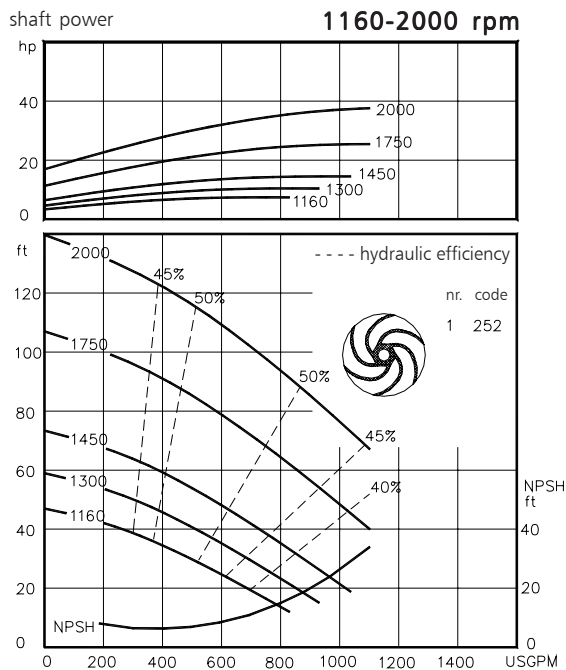
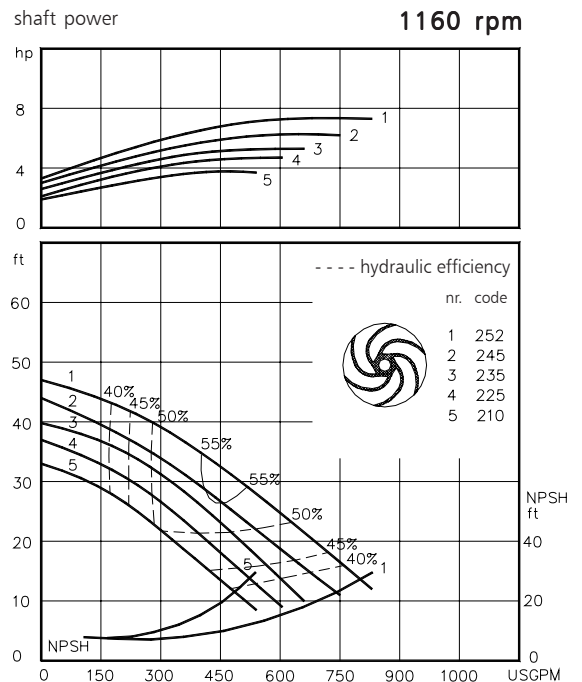
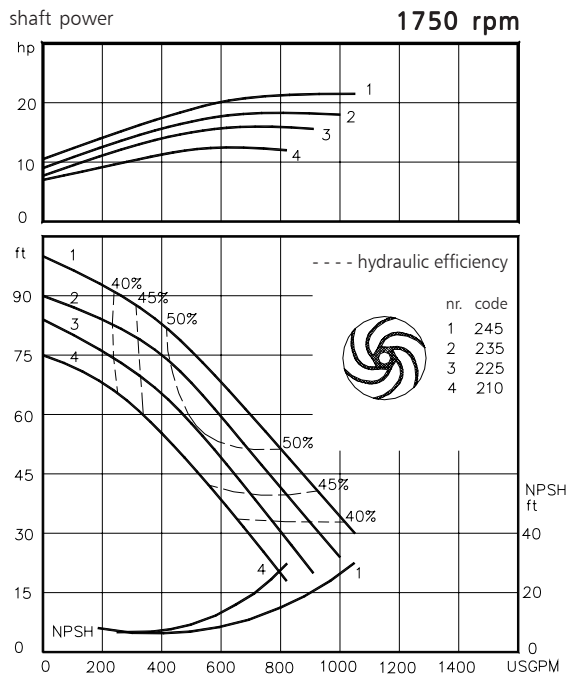

Available electric motors Degree of protection IP55		
NEMA	[hp]	[rpm]
184T	2.0	1160
213T	3.0	1160
215T	5.0	1160
213T	7.5	1750
215T	10	1750
254T	15	1750
215T	15	3500
254T	20	3500
256T	25	3500
284TS	30	3500

[www.ittwwwalphen.com](http://www.ittwwwalphen.com)

*Engineered for life*



# ITT

## ROBOT PUMPS

### Installation options

### BW4041



**H**

Horizontal installation:  
Bare shaft

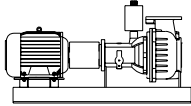

**HM**

Horizontal installation:  
With foundation plate  
and electric motor.



**V**

Vertical installation:  
Bare shaft

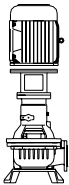

**VM**

Vertical installation:  
With support and electric  
motor.

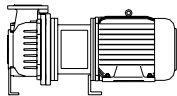

**HS**

Short coupled:  
Horizontal installation.

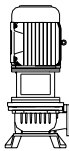

**VS**

Short coupled:  
Vertical installation.

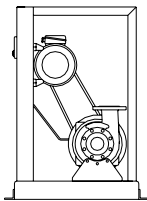

**K**

V-belt driven:  
Frame construction.  
For motors NEMA  
145T - 324T.

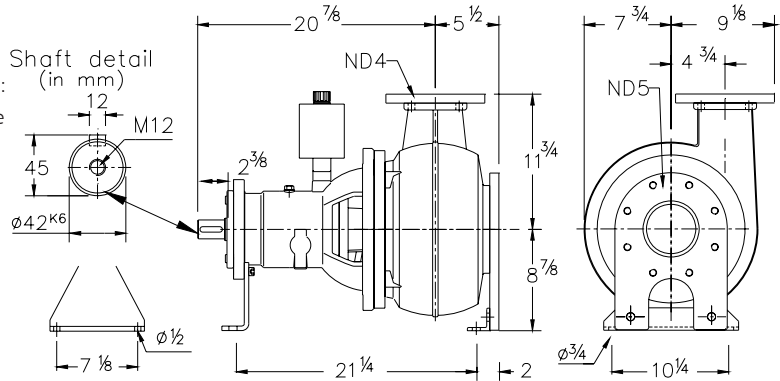

#### Flange connections

Standard

	p.c.d.	ANSI 150 Number x holes
Discharge ND 4	7 1/2	8 x $\varnothing$ 7/8
Suction ND 5	8 1/2	8 x 3/4 UNC

Weight (H version): 209 lbs

#### Optional:

- seal flushing

*Other options and materials upon request*

### Materials

sealhousing	: 1
pump casing	: 1
impeller	: 2 5 6 7
pump shaft	: 3 5
bearing housing	: 1
bolts	: 4 5
elastomer	: 8+9 10
seal lubrication	: oil
pump seal	: silicon carbide-silicon carbide
secondary seal	: carbon - ceramic
primer	: Alkyd primer
top coating	: Two component high-build polyurethane coating

1	cast iron	ASTM A-48 Cl.35
2	sg cast iron	ASTM A445 Gr.60-46-18
3	stainless steel	AISI 431
4	stainless steel	AISI 304
5	stainless steel	AISI 316
6	stainless steel	AISI 329
7	wear resistant sg iron	HB500
8	nitrile	(NBR)
9	neoprene	(CR)
10	viton	(FPM)

We reserve the right to alter specifications without prior notice.