



ITT

ROBOT PUMPS

Channel pump

RC2202BE

50 Hz

The channel impeller pumps are designed to pump lightly contaminated waste water at high efficiencies. RC pumps are equipped with an open channel impeller running against an adjustable suction cover. Excellent for drainage or leakage water.

Pump

solids passage : 8 mm
 suction diameter : 8 mm screen
 discharge diameter : 40 mm
 impeller diameter : 146 mm
 recommended minimum flow : 0.5 l/s (2 m³/h)

Motor

rated shaft power : 2.6 kW
 rated electrical power : 3.5 kW
 mains : 50 Hz - 3 phase
 speed : 2900 rpm
 motor efficiency : 74 %
 rated power factor (cos phi) : 0.90
 degree of protection : IP 68
 isolation class : F (155 °C)
 max. water temperature : 40 °C
 (higher temp. on request)
 standard cable length : 10 m

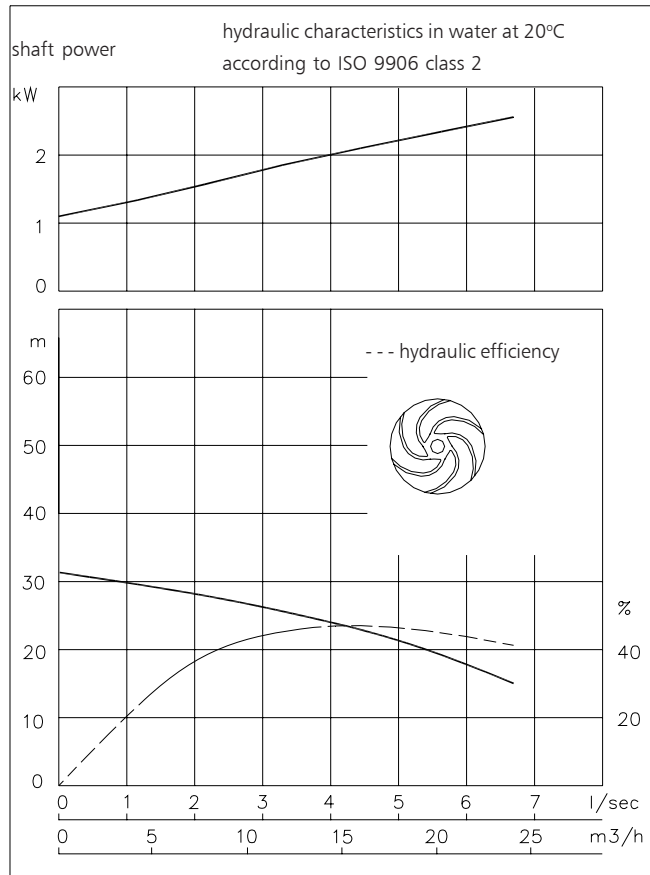

Pump curves are for cast iron only.

Materials

motor housing : 1
 seal housing : 1
 volute : 1
 impeller : 1
 suction cover : 7
 shaft : 3 5
 bolts : 4 5
 elastomers : 8+9 10
 electrical cable : 9
 mechanical seals : oil lubricated
 pump seal : silicon carbide-silicon carbide
 motor seal : carbon-ceramic
 primer : Alkyd primer
 top coating : Two component high-build polyurethane coating

1	cast iron	EN-GJL-250
2	sg cast iron	EN-GJS-400-15
3	stainless steel 431	X20 CrNi 17 2
4	stainless steel 304	X5 CrNi 18 10
5	stainless steel 316	X5 CrNiMo 17 12 2
6	stainless steel 329	X4 CrNiMoN 27 5 2
7	wear resistant sg iron	HB 500
8	nitrile	(NBR)
9	neoprene	(CR)
10	viton	(FPM)

www.ittwwwalphen.com

Engineered for life



ITT

ROBOT PUMPS

Installation options

RC2202BE

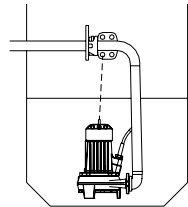

H
Header coupling:
Type HK50

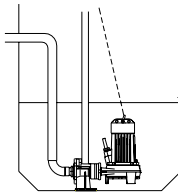

V
Guide bar coupling:
Type V50

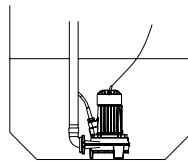

F
Freestanding:
With 50mm hose
adapter
or R2" threaded
connection

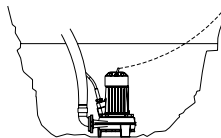

T
Transportable:
With 50mm hose
adapter
or R2" threaded
connection

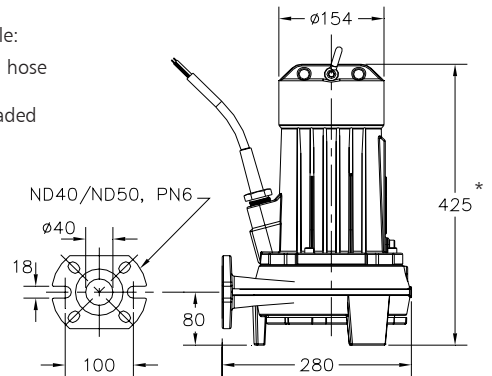
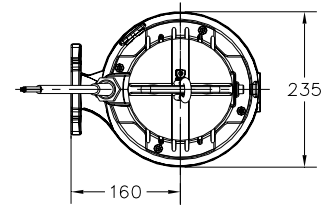

The motor is cooled by the surrounding water.

* version E: 539

Version

Weight

B Basic

47 kg

E Explosion proof version

54 kg

Certified according to: II 2 G Ex de IIB c T4

Optional:

Thermoswitches in motorwindings
Standard for explosion proof version (2 sets)

Flexible protective sheating for cable
(AISI 316)

Water detector in motor and oil housing
(for explosion proof version only in oil housing with external cable)

Motor connection details

voltage [V]*	rated current[A]	number of cables x number of cores x cross section [mm ²]					
				with waterdetector and/or thermoswitches		explosion proof version	
		DOL-start	YD-start	DOL-start	YD-start	DOL-start	
220	10.2	1x4x1.5	1x7x1.5	1x7x1.5	1x10x1.5	1x7x2.5	
380	5.9	1x4x1.5	1x7x1.5	1x7x1.5	1x10x1.5	1x7x2.5	
400	5.6	1x4x1.5	1x7x1.5	1x7x1.5	1x10x1.5	1x7x2.5	
415	5.4	1x4x1.5	1x7x1.5	1x7x1.5	1x10x1.5	1x7x2.5	
500	4.5	1x4x1.5	1x7x1.5	1x7x1.5	1x10x1.5	1x7x2.5	

starting current DOL-start : 4.6 x rated current

* other voltages on request

starting current YD-start : 1.5 x rated current

We reserve the right to alter specifications without prior notice.