

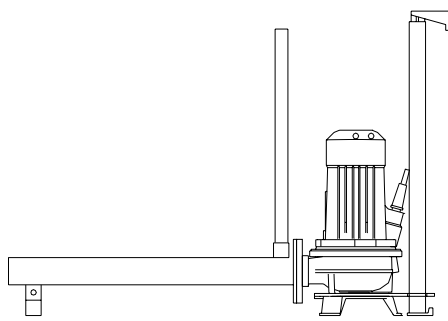

Information Technique

RSB 70 avec pompe RW

- Type de pompe:
 1 RW2110BD ø125
 2 RW2110BE ø138
 3 RW2110BH ø150



- passage intégral ø35 mm

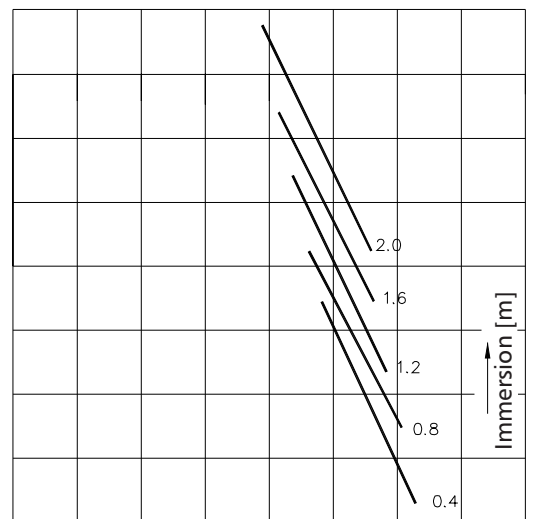
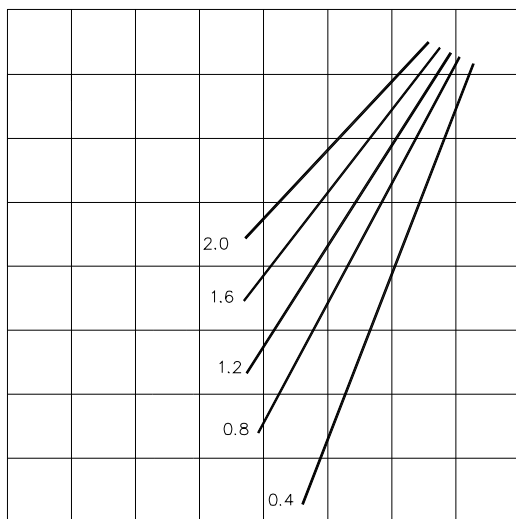
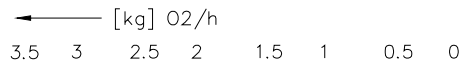
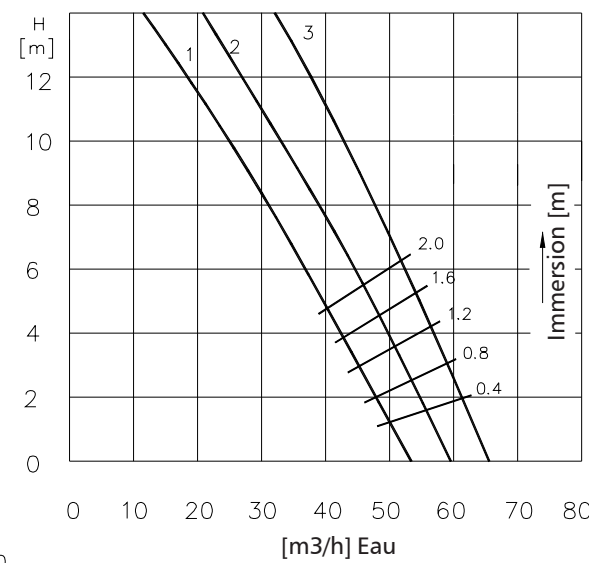
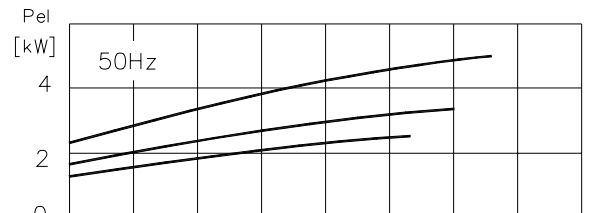



ITT

ROBOT PUMPS

Information Technique

RSB 100 avec pompe RT

- Type de pompe
 1 RT2030DG ø1190
 2 RT4040DJ ø1195
 3 RT4040DL ø207
 4 RT4040DO ø226

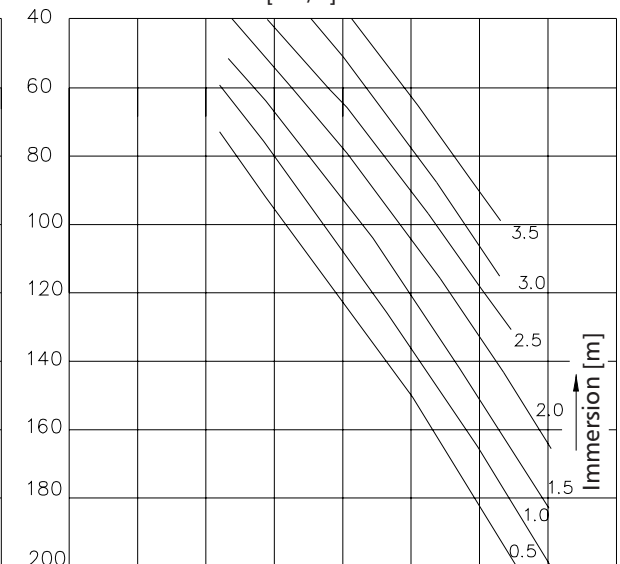
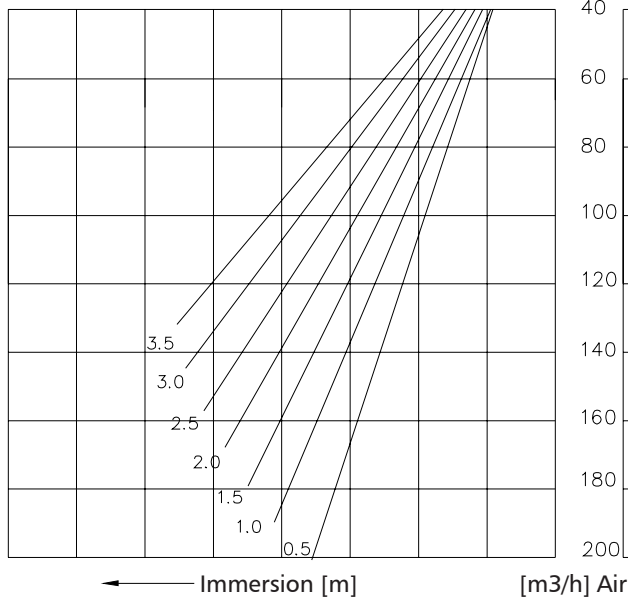
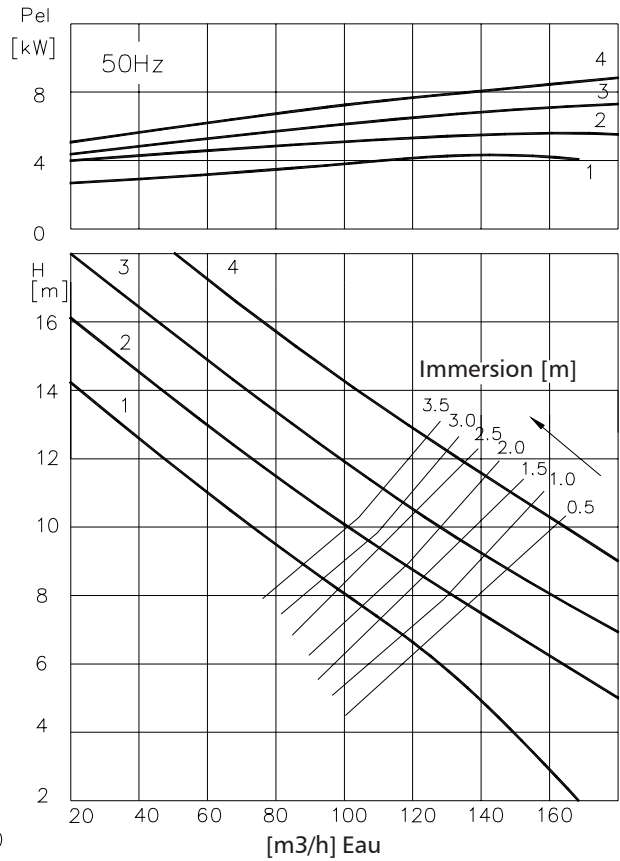
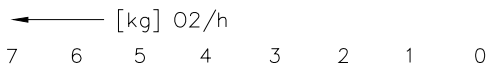
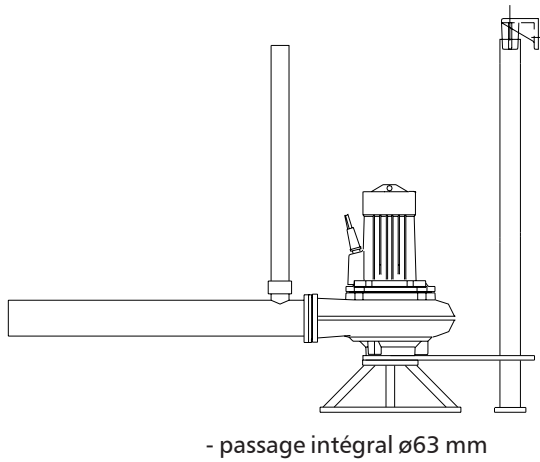



ITT

ROBOT PUMPS

Information Technique

RSB 100 avec pompe RW

- Type de pompe
 1 RW4030DJ ø215
 2 RW4030DL ø230
 3 RW4030DO ø245
 4 RW4041DU ø245

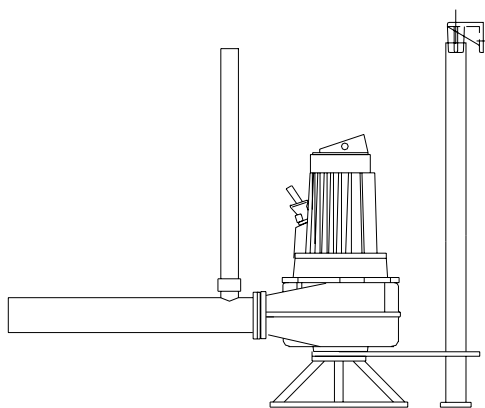

- passage intégral ø63 mm

← [kg] O₂/h
 7 6 5 4 3 2 1 0

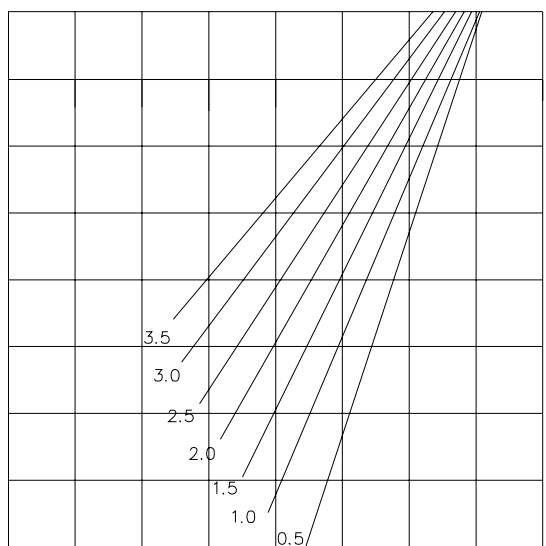

← Immersion[m] [m³/h] Air

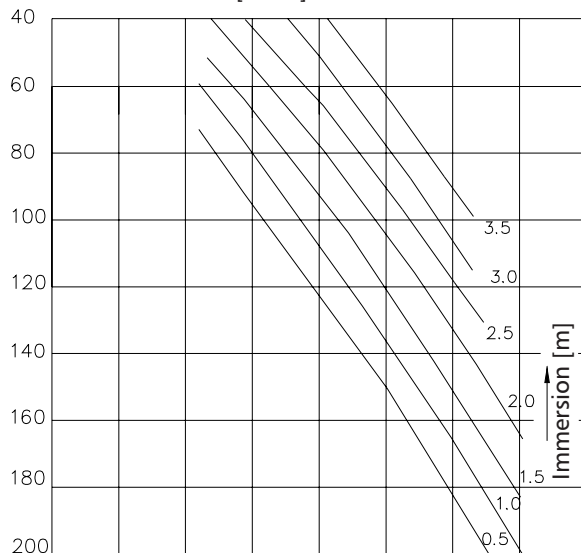
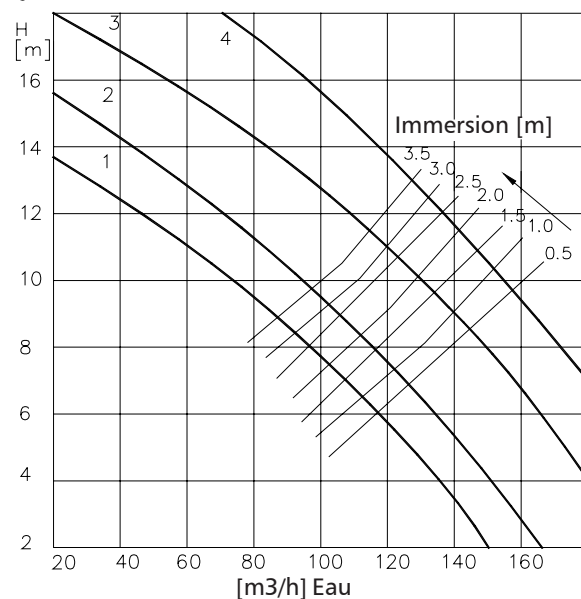
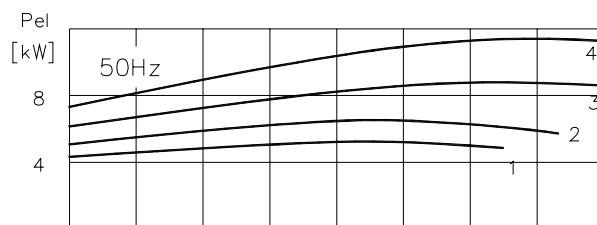



ITT

ROBOT PUMPS

Information Technique

RSB 150 avec RT pompe RT

Type de pompe
1 RT4042DU ø235
2 RT4042DZ ø245

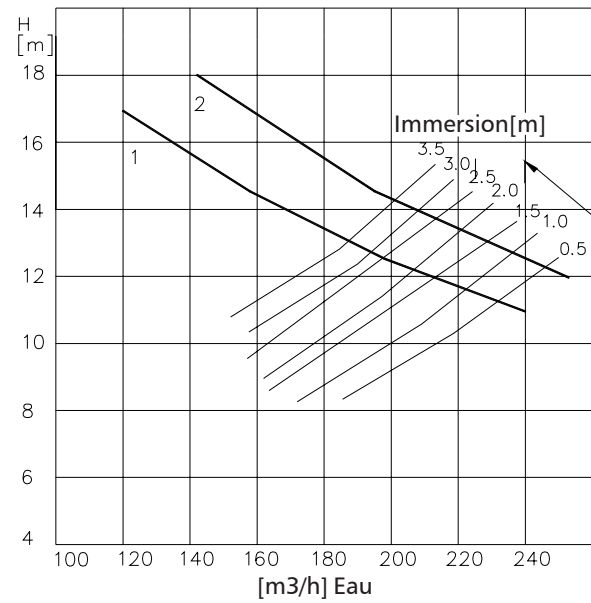
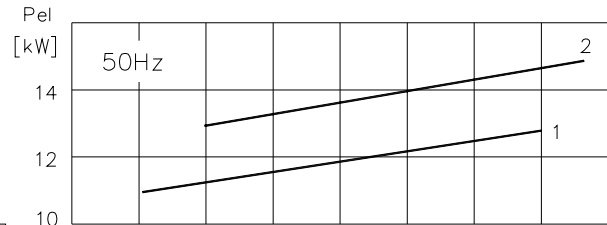
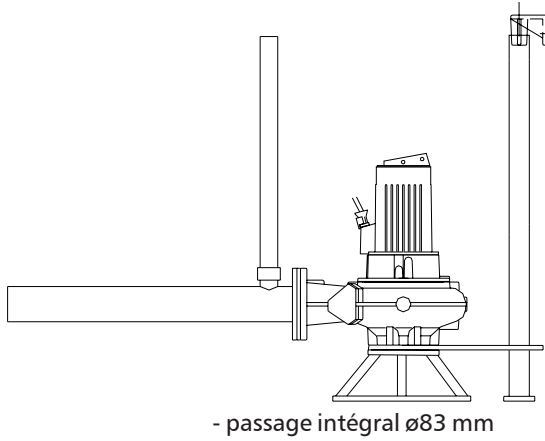

← [kg] O₂/h
9 8 7 6 5 4 3 2

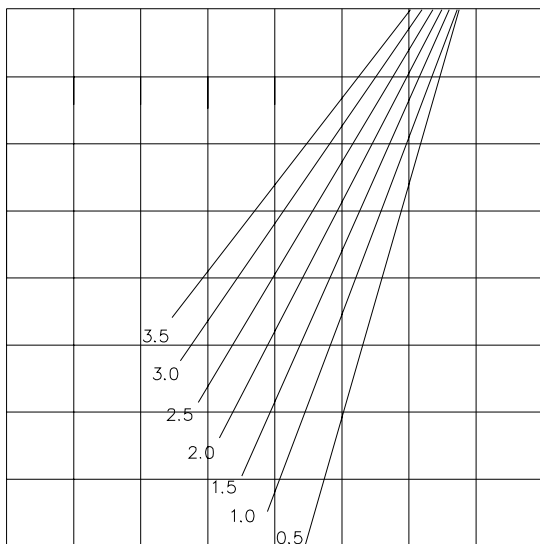

← Immersion [m] [m³/h] Air

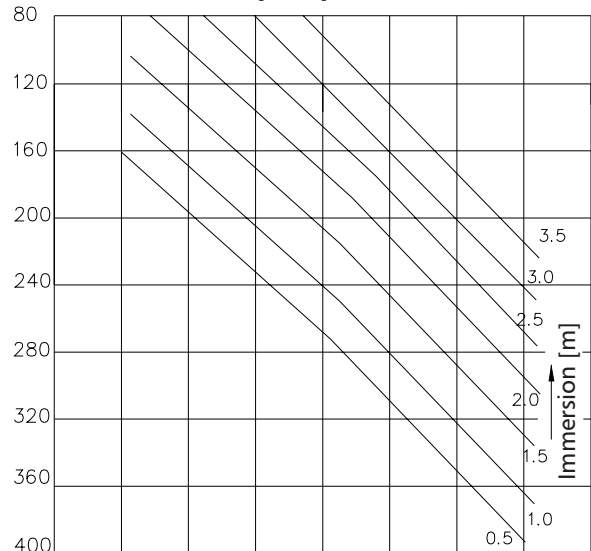



ITT

ROBOT PUMPS

Information Technique

RSB 150 avec pompe RW

- Type de pompe
 1 RW6141LD ø215
 2 RW6141LF ø225
 3 RW6141LF ø235

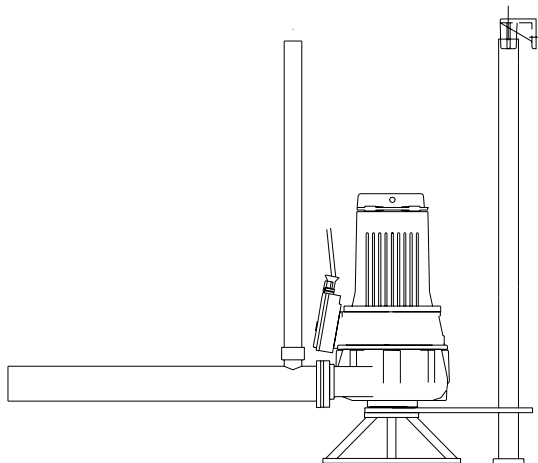

- passage intégral ø83 mm

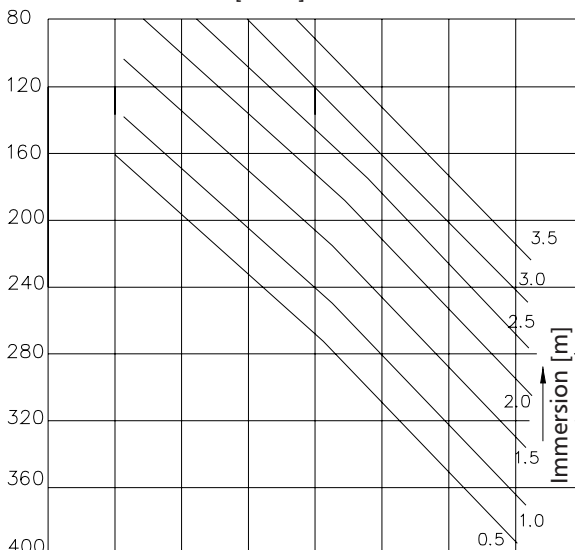
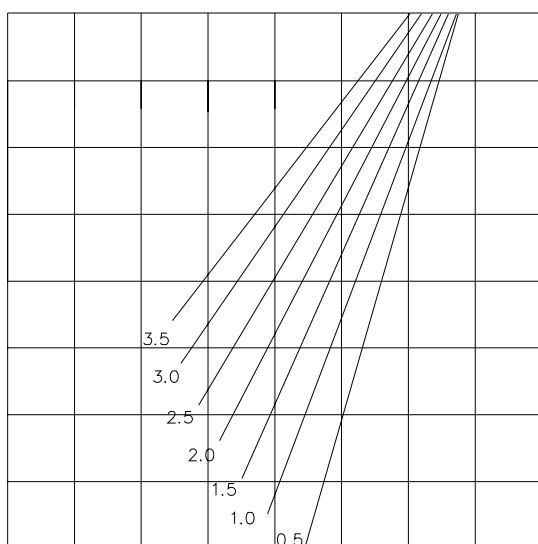
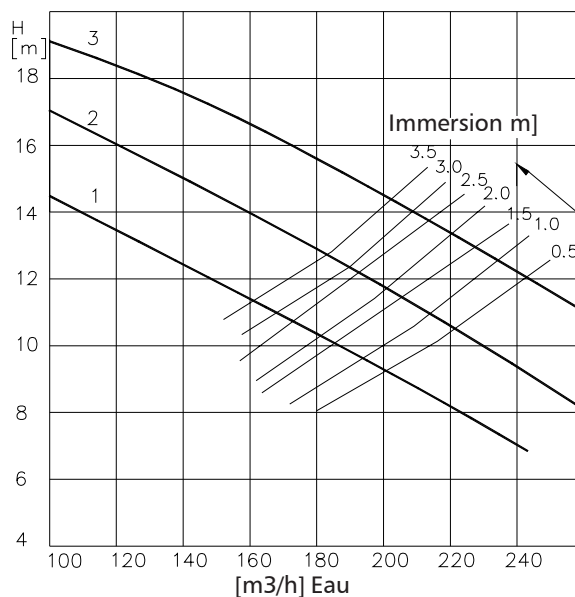
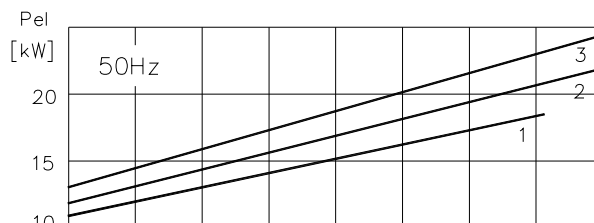
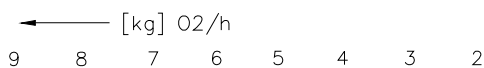

← [m³/h] Air